

INTRODAGE PÅ PERSONVOGNSMEKANIKER

NAVNE OG KLASSE

1



INTRODAGE PÅ
PERSONVOGNSMEKANIKER

2



MØD KRISTIAN
SOM ER PERSONVOGNMEKANIKER



© EduCreation ApS

Produceret af



Finansieret af





AFMONTERING AF HJUL & BREMSESKIFT

1 AFMONTERING AF HJUL

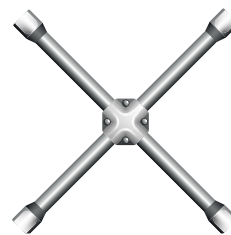

2 VÆRKTØJ TIL BREMSESKIFT



Momentnøgle



21 mm top

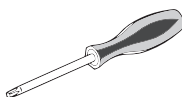

Torx 30



Skraldenøgle



12 mm fastnøgle



Skydelærer

3 AFMONTERING AF BREMSEKALIBER

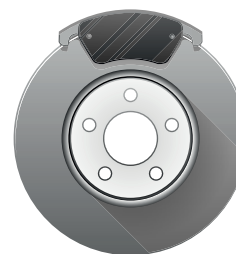

Hvad er standen på bremsesystemet?

God

Mellem

Dårlig

4 KONTROL AF SKIVER OG KLODSER



Hvad er tykkelsen på bremseskiven? _____ mm

Hvad er standen på bremseskiven?

God

Mellem

Dårlig

Hvad er tykkelsen på bremseklodserne? _____ mm

Hvad er standen på bremseklodserne?

God

Mellem

Dårlig

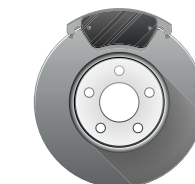
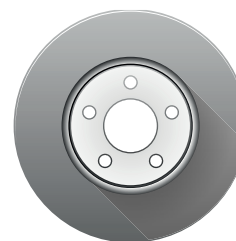

5 AFMONTERING/MONTERING AF NY BREMSESKIVE



6 MONTERING AF NY BREMSEKALIBER



7 MONTERING AF NYT HJUL





HJUL OG BREMSESKIFT



NAVNGIV DE RIGTIGE DELE

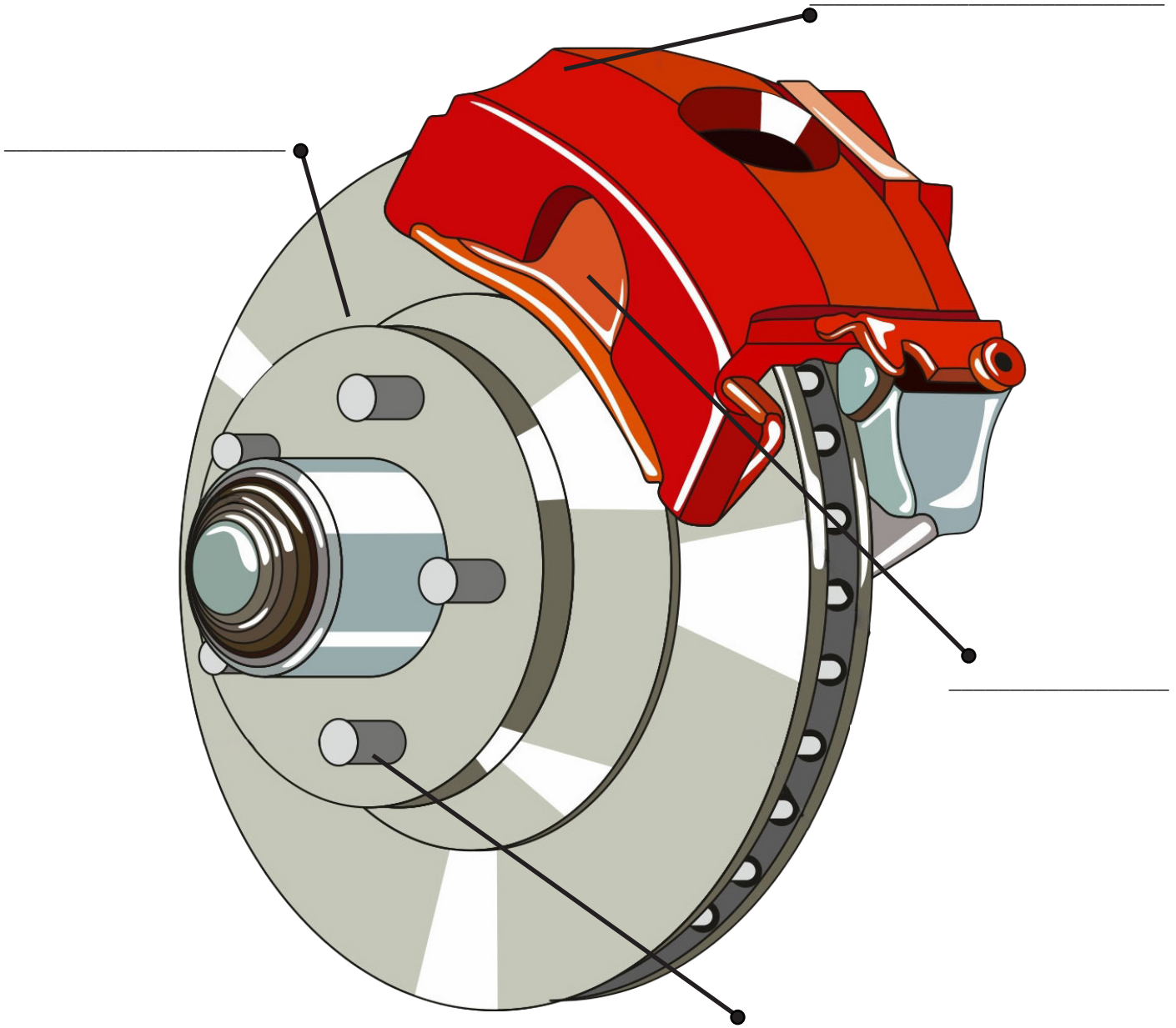

HVAD HAR VI LÆRT?

Hvor meget af hjul og bremsekift kunne I forvejen?



Hvor meget af det, I lærte kan direkte bruges som mekaniker?





HJUL OG DÆK TJEK



VÆRKTØJ TIL HJUL



Dæktryksmåler



Skydelærer



Hjul til montering

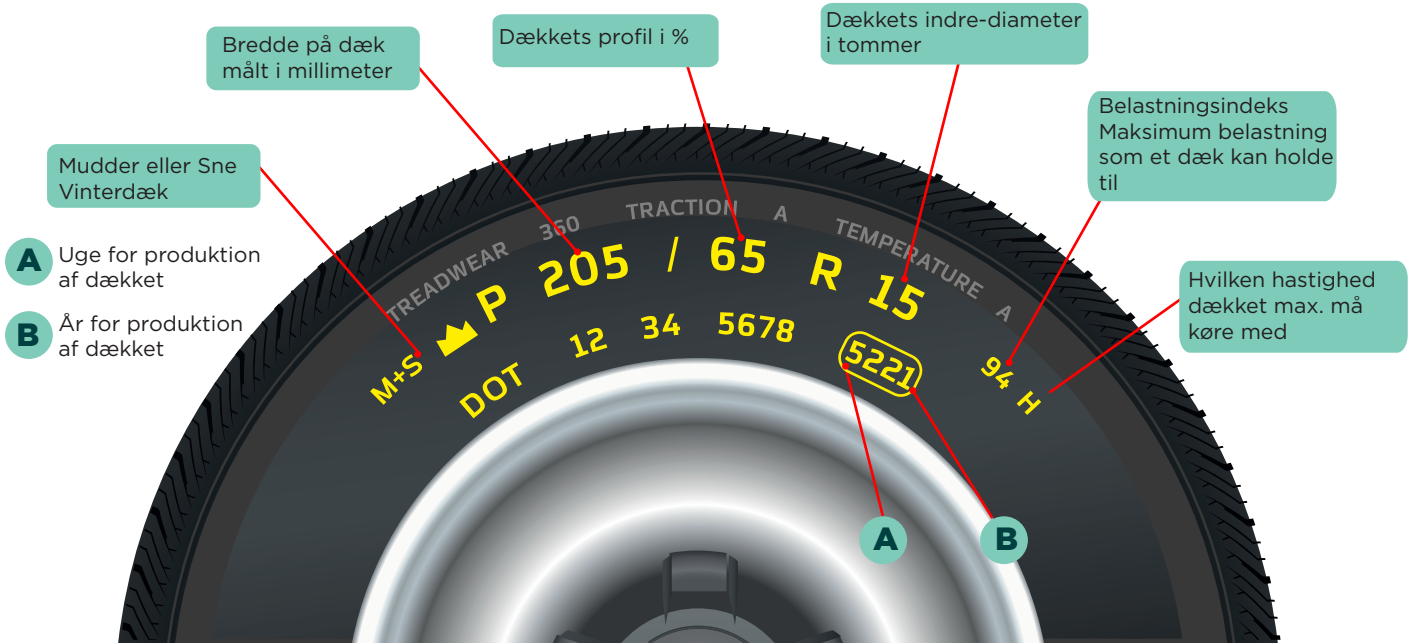

1

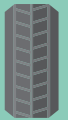

TJEK AF SLIDBANE



Slidbane måling: _____mm

Vil være ok at køre videre på:

Ja

Nej

3



DÆKTRYK



Dæktrykmåling

_____ Bar/psi

Skal pumpes op:

Ja

Nej

2

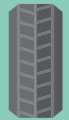

FORSTÅ DÆKKET



Sommer eller vinterdæk Ja

Nej

Dækkets bredde i mm _____

Dækkets profil i % _____

Dækkets indre-diameter i tommer _____

Hvornår er dækket produceret _____ Uge _____ År

Belastningsindeks : _____
(Spørg underviser for tabel)

Max. hastighed for dækket: _____
(Spørg underviser for tabel)